

USBIM and USBIM-Lite Orbit 3 Interface Modules

Description

The USBIM enables the Orbit 3 Network to interface with a Controller PC USB port allowing Data to be transferred between the Orbit Network and a PC. Two options are available, the standard USBIM which can connect with up to 250 Orbit Modules and a lower cost USB-Lite small Orbit Digital Measurement Networks up to 4 modules where the user does not require the full power of the standard USBIM



Applications

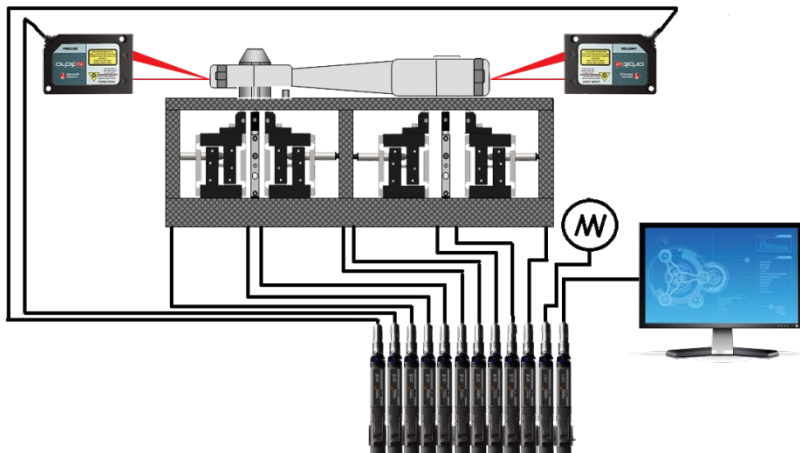

Solartron Flexure Contact Transducers and Non-Contact Laser Triangulation Transducers. Connected to controlling PC via USB Controller.

Precision. Quality. Reliability

www.solartronmetrology.com • sales.solartronmetrology@ametek.com

Applications

The USBIM - Lite is designed for measurement application where 4 or less sensors are required. For example a basic diameter measurement, where the USBIM-Lite is Running (2) probes and for a diameter check and using a DIOM to indicate process status

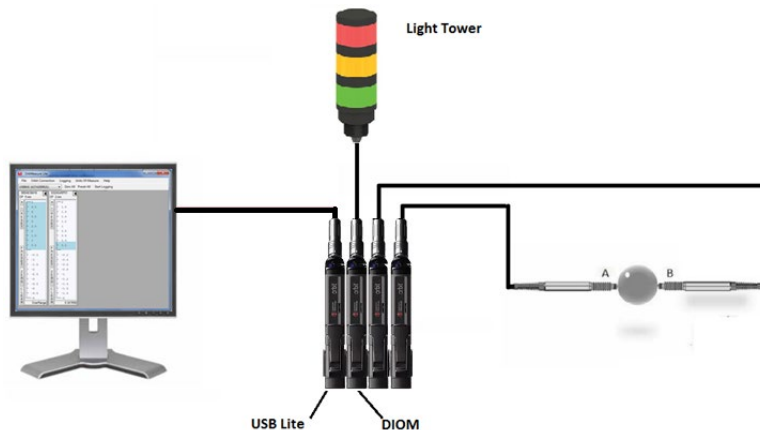

Benefits

The USBIM – Lite is fully compatible with all of Solartron Orbit products and interfaces with all of Solartron Software.

Applications: Bearings

In bearing manufacture it is necessary to match bearing races to the best ball size to create the best bearings.

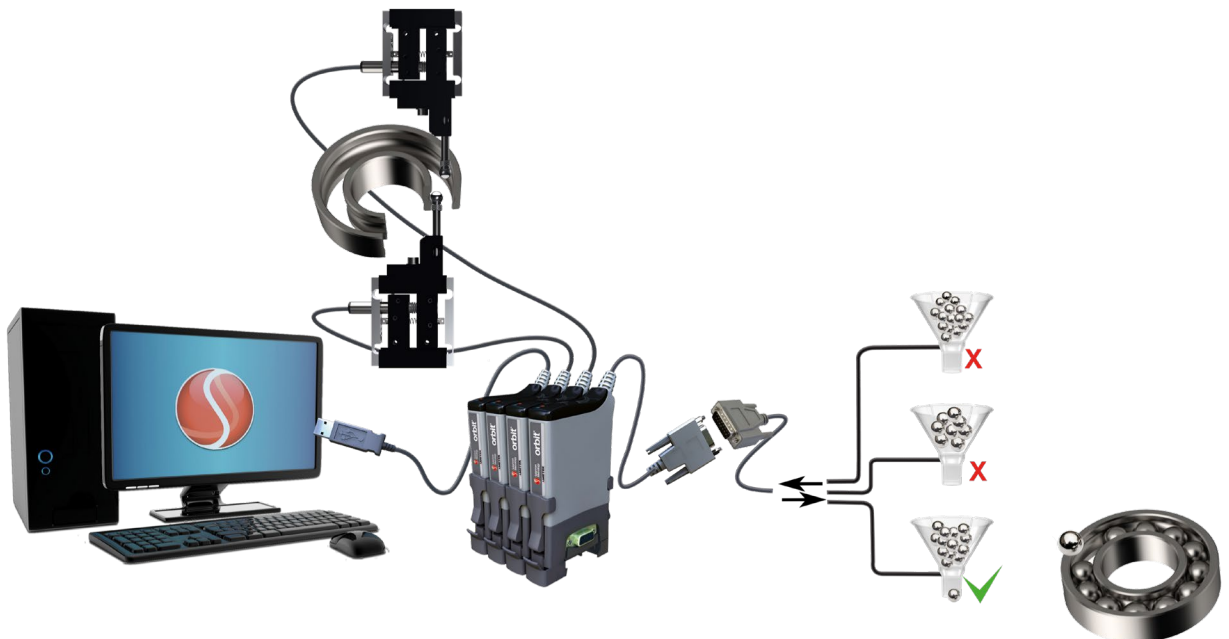

In this application a USBIM-Lite provides the interface to two Solartron flexures that check the size of a bearing race, this data is then processed by Orbit and a DIOM2 is used to select the correct size balls to best match the race. The flexures provide excellent repeatable measurements with a very long life

Applications: Wireless Hand Gauges

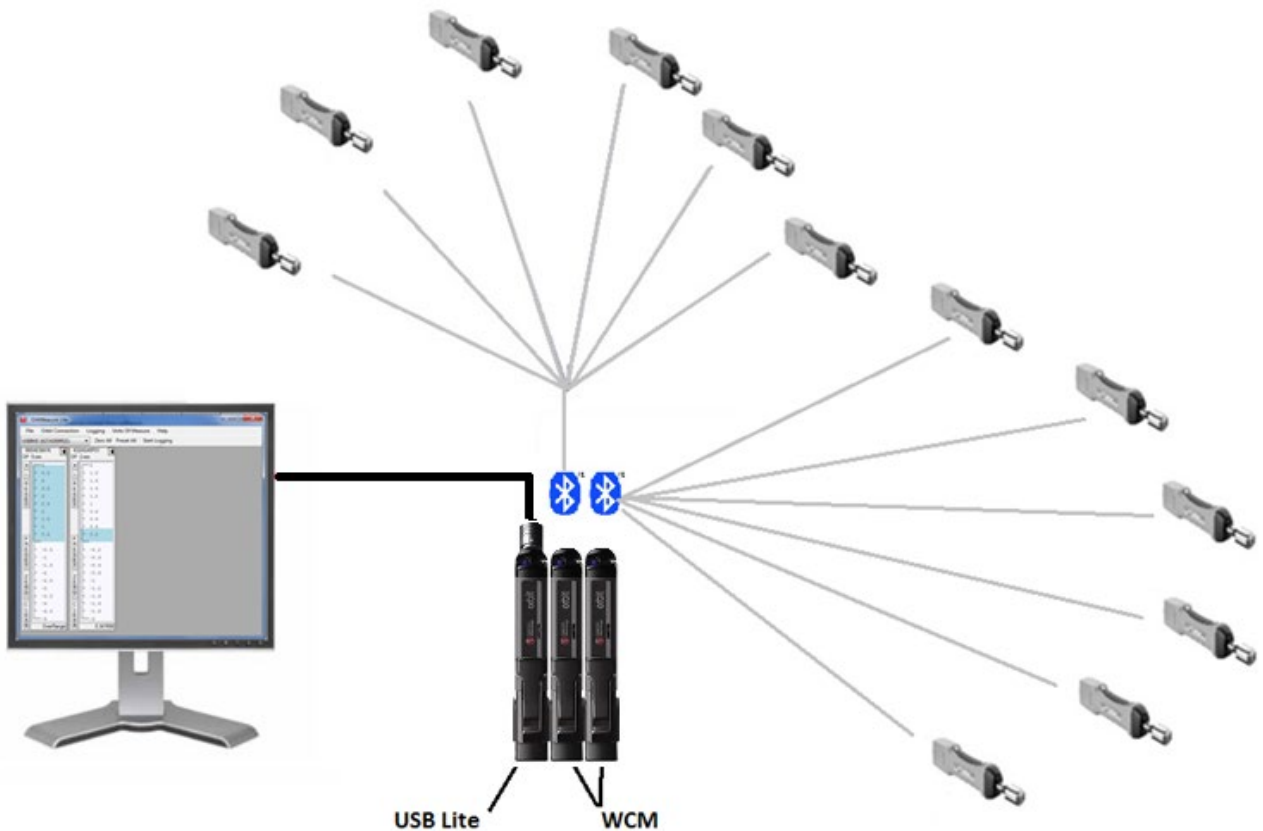

In this application a USBIM-Lite is connected to two of Solartron's Orbit Wireless Control Modules (WCM) as each WCM is capable of interfacing with 6 wireless Hand Tools this brings 12 hand tools into the Orbit Network

Precision. Quality. Reliability

www.solartronmetrology.com • sales.solartronmetrology@ametek.com

Technical Specification

Products	USBIM	USBIM - Lite
Environmental		
Sealing	IP43 for module and TCON	
Electronics Operating and Storage Temperature (°C)	0 to 60	
EMC Emissions	EN61000-6-3	
EMC Immunity	EN61000-6-2	
Safety	EN61010:2010	
ROSH	Fully ROSH Compliant	
Vibration	10g up to 2kHz	
Material		
Cable	PUR	
Electronics Module	ABS	
Electronics Interface		
Protocol	USB2 to Solartron Orbit3	
Number of Orbit3 Modules/Probes (see Note 1)	250	4
Data Rate (max) Baud	12 Mbps	
Reading Rate	3906 readings per second	
Power (no load)	5±0.25 VDC @ 0.25A typical	

Note 1 : The USBIM can interface with up to 250 Solartron Orbit3 Modules, the USBIM-Lite can interface with up to 4 modules. Both versions can also power up to 4 modules depending on the individual module power requirements. The Orbit Suite - Network Power Calculator should be used to establish if the USBIM-Lite can power the chosen module without requiring an additional power supply (PSIM).

For further technical information and how to use the USBIM and USBIM-Lite please refer to the Orbit System Manual 502990 which is available on the Solartron Metrology website.

Dimensions

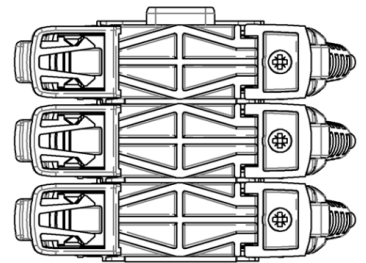
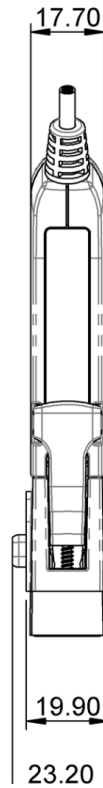
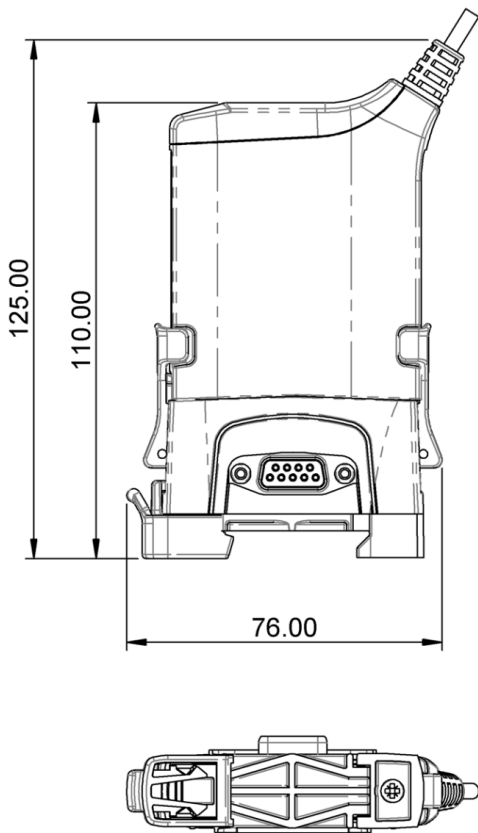

Precision. Quality. Reliability

www.solartronmetrology.com • sales.solartronmetrology@ametek.com

Sales Offices

UK (Headquarters and Factory)

Solartron Metrology
Bognor Regis, West Sussex, PO22 9ST
Tel: +44 (0) 1243 833 333
Fax: +44 (0) 1243 833 332
Email: sales.solartronmetrology@ametek.com

France

AMETEK SAS
Solartron Metrology Division
Elancourt, 78990 France
Tel: +33 (0) 1 30 68 89 50
Fax: +33 (0) 1 30 68 89 99
Email: info.solartronmetrology@ametek.com

Germany

AMETEK GmbH
Solartron Metrology Division
40670 Meerbusch
Tel: +49 (0) 2159 9136 500
Fax: +49 (0) 2159 9136 505
Email: vertrieb.solartron@ametek.com

China

AMETEK Commercial Enterprise (Shanghai)
Co., Ltd
Shanghai, 200131, China
Tel: +86 21 5763 2509
Email: china.solartronmetrology@ametek.com

North America

Solartron Metrology
USA Central Sales Office
Gastonia, NC 28054
Tel: +1 800 873 5838
Email: usasales.solartronmetrology@ametek.com

Distributors

Solartron have 30+ distributors worldwide, see website www.solartronmetrology.com for your nearest distributor

Precision Driven...

In the laboratory, on the shop floor or in the field, Solartron Metrology's products provide precise linear measurements for quality control, test and measurement and machine control. Solartron Metrology is a world leader in the innovation, design and manufacture of precision digital and analogue dimensional LVDT gauging probes, displacement sensors, optical linear encoders and associated instrumentation.

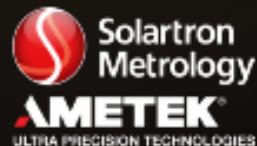

Solartron Metrology pursues a policy of continuous development. Specifications in this document may therefore be changed without notice.